

600 - RETURN ALUMINUM LOUVERED FACE GRILLE

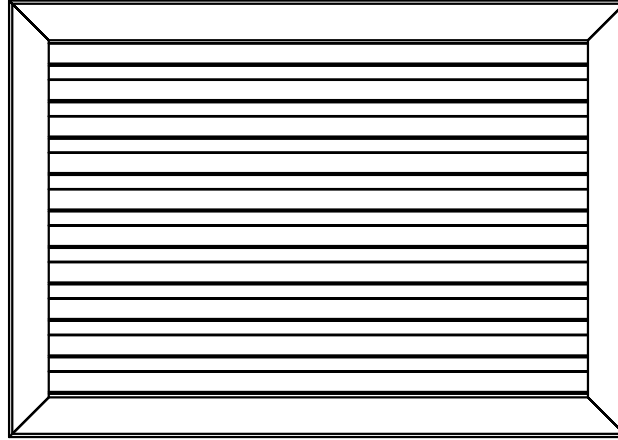

RETURN:

□ **630**

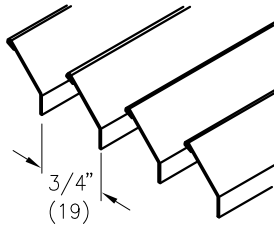

45° FIXED BLADES

□ **635**

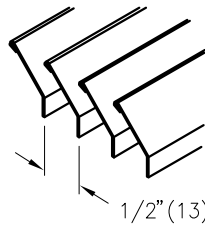

45° FIXED BLADES

□ **610Z**

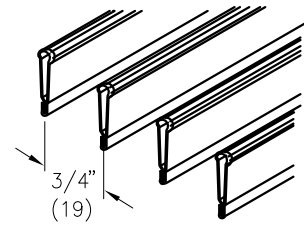

0° FIXED BLADES

BLADE ORIENTATION:

□ **L**

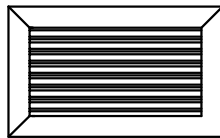

FRONT BLADES PARALLEL TO LONG DIMENSION

□ **S**



FRONT BLADES PARALLEL TO SHORT DIMENSION

MATERIAL:

- GRILLE: ALUMINUM CONSTRUCTION
- PANEL: STEEL CONSTRUCTION (3P, 916P & 17P)
ALUMINUM CONSTRUCTION (3PA, 916PA & 17PA)

NOTES:

- FOR 630 AND 635 GRILLES, MULLIONS ARE INCLUDED WHEN BLADES ARE PARALLEL TO NOMINAL SIZE DIMENSION LARGER THAN 8" (203)
- FOR 610Z GRILLES, VISIBLE MULLIONS ARE INCLUDED WHEN BLADES ARE PARALLEL TO NOMINAL SIZE DIMENSION LARGER THAN 24" (610)

ALL METRIC DIMENSIONS () ARE SOFT CONVERTED. IMPERIAL DIMENSIONS ARE CONVERTED TO METRIC AND ROUNDED TO THE NEAREST MILLIMETER.

| | | | |
|------------------------|----------------------|---------------------------|--|
| PROJECT: | | PRICE [®] | |
| ENGINEER: | | <i>MG</i> 269914 | 600 SERIES RETURN ALUMINUM LOUVERED FACE GRILLE |
| CUSTOMER: | | | |
| SUBMITTAL DATE: | SPEC. SYMBOL: | 2020/02/10 | |

600 - RETURN ALUMINUM LOUVERED FACE GRILLE

LAY-IN FRAMES:

□ **F** - 1 1/4" (32) FLAT FRAME FOR 1 5/16" (24) FLAT TEE

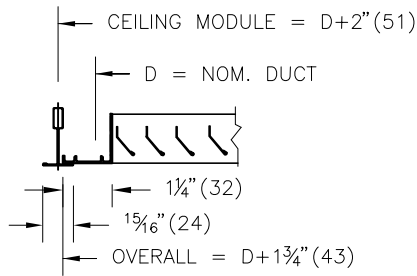

□ **NF** - 3/4" (19) FLAT FRAME FOR 1 5/16" (24) FLAT TEE

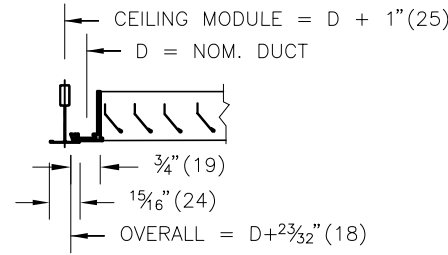

□ **3P** - STEEL PANEL FOR 1 5/16" (24) FLAT TEE

□ **3PA** - ALUMINUM PANEL FOR 1 5/16" (24) FLAT TEE

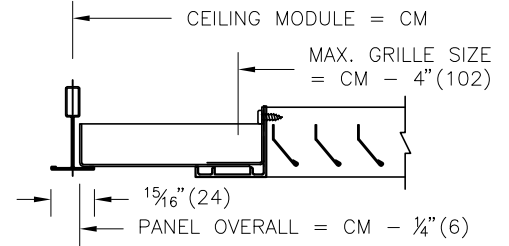

□ **17P** - STEEL PANEL FOR 9/16" (14) BOLT SLOT OR TEGULAR TEE

□ **17PA** - ALUMINUM PANEL FOR 9/16" (14) BOLT SLOT OR TEGULAR TEE

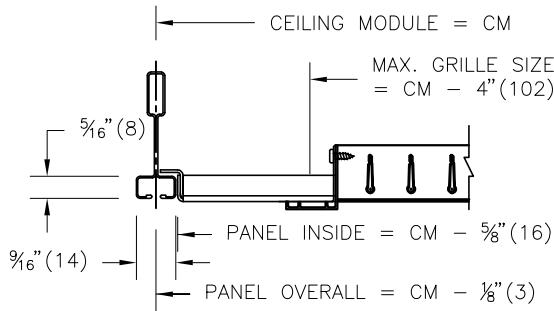

□ **916P** - STEEL PANEL FOR 9/16" (14) FLAT TEE

□ **916PA** - ALUMINUM PANEL FOR 9/16" (14) FLAT TEE

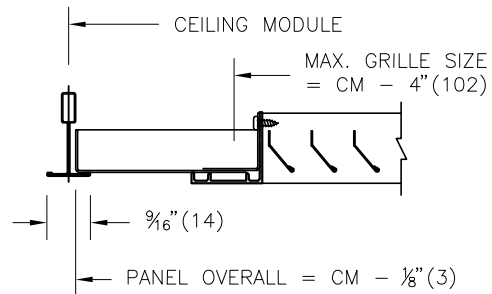

SURFACE MOUNT FRAMES:

□ **N** - 1" (25) NARROW FRAME

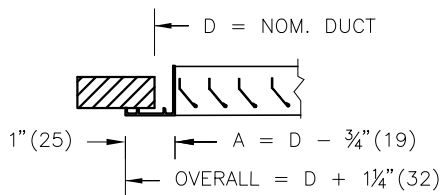

□ **F** - 1 1/4" (32) FLAT FRAME

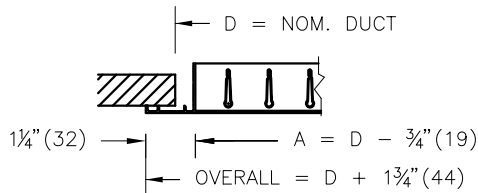

□ **D** - 3/8" (10) FLAT MOUNTING FRAME WITH 1 1/4" (32) FRAME

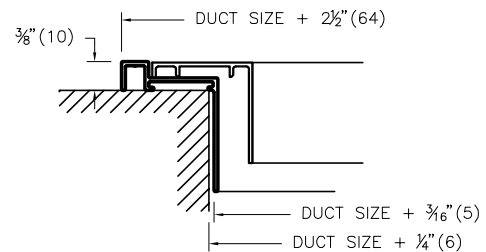

AVAILABLE SIZES:

- MINIMUM SIZE 6" x 4" (152x102)
- MAXIMUM SIZE ONE PIECE CONSTRUCTION 48" x 48" (1219x1219)
- 3P, 3PA, 17P, 17PA, 916P AND 916PA PANELS:
 - 12" x 12" (305x305) CEILING MODULE
 - 24" x 12" (610x305) CEILING MODULE
 - 24" x 24" (610x610) CEILING MODULE
 - 48" x 24" (1219x610) CEILING MODULE
- F AND N FRAMES AVAILABLE FOR SURFACE MOUNT APPLICATIONS IN MULTIPLE SECTIONS WITH MULLIONS AND DUCT MOUNTING CHANNELS - SEE PAGE 5 FOR DETAILS

ALL METRIC DIMENSIONS () ARE SOFT CONVERTED. IMPERIAL DIMENSIONS ARE CONVERTED TO METRIC AND ROUNDED TO THE NEAREST MILLIMETER.

| | | | |
|------------------------|----------------------|---------------------|--|
| PROJECT: | | PRICE® | |
| ENGINEER: | | <i>mg</i> 269914 | 600 SERIES RETURN ALUMINUM LOUVERED FACE GRILLE |
| CUSTOMER: | | | |
| SUBMITTAL DATE: | SPEC. SYMBOL: | 2020/02/10 | |

600 - RETURN ALUMINUM LOUVERED FACE GRILLE

SPIRAL DUCT FRAME:

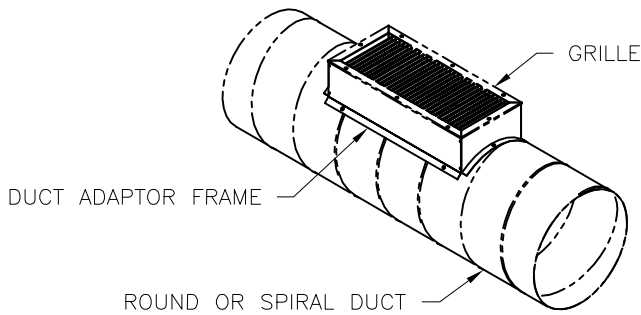
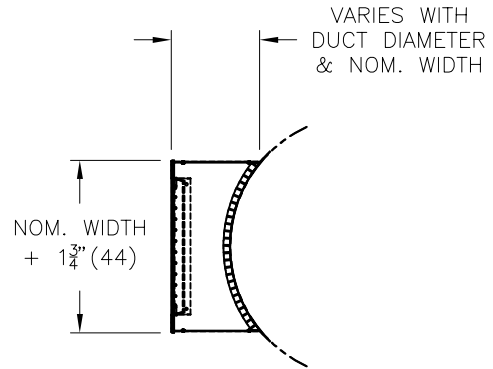
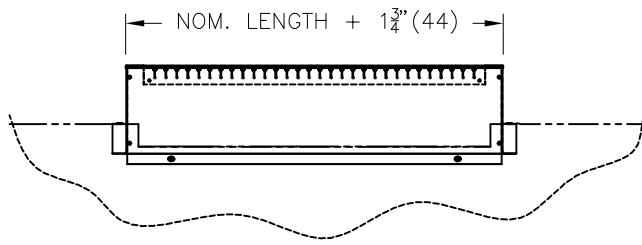

MATERIAL:

- ADAPTOR FRAME - GALVANIZED STEEL

FINISH:



- ADAPTOR FRAME - MILL FINISH

NOTES:

- INTENDED FOR USE IN SPIRAL OR ROUND DUCT APPLICATIONS
- AVAILABLE SIZES:
MIN. 6" x 4" (152 x 102)
MAX. 36" x 16" (914 x 406)
- AVAILABLE IN 1" (25) INCREMENTS
- OPEN CELL FOAM INSULATION PROVIDES A TIGHT SEAL AROUND THE GRILLE OPENING IN ANY ROUND DUCT
- FITS 600 SERIES GRILLES WITH "F" FRAME
- FACTORY TOLERANCE $\pm 1/32"$ (1)
- GRILLE COMES WITH "A" COUNTERSUNK SCREW MOUNTING

| NOM. DUCT DIAMETER | MIN. NOM. GRILLE WIDTH | MAX. NOM. GRILLE WIDTH |
|--------------------|------------------------|------------------------|
| 10" (254) | 4" (102) | 8" (203) |
| 12" (305) | 4" (102) | 9" (229) |
| 14" (356) | 4" (102) | 11" (279) |
| 16" (406) | 4" (102) | 12" (305) |
| 18" (457) | 4" (102) | 13" (330) |
| 20" (508) | 4" (102) | 14" (356) |
| 22" (559) | 4" (102) | 15" (381) |
| 24" (610) | 4" (102) | 16" (406) |
| 26" (660) | 4" (102) | 16" (406) |
| 28" (711) | 4" (102) | 16" (406) |
| 30" (762) | 4" (102) | 16" (406) |
| 32" (813) | 4" (102) | 16" (406) |
| 34" (864) | 4" (102) | 16" (406) |
| 36" (914) | 4" (102) | 16" (406) |
| 38" (965) | 4" (102) | 16" (406) |
| 40" (1016) | 4" (102) | 16" (406) |
| 42" (1067) | 12" (305) | 16" (406) |
| 48" (1219) | 12" (305) | 16" (406) |

ALL METRIC DIMENSIONS () ARE SOFT CONVERTED. IMPERIAL DIMENSIONS ARE CONVERTED TO METRIC AND ROUNDED TO THE NEAREST MILLIMETER.

| | | |
|------------------------|----------------------|---|
| PROJECT: | |  |
| ENGINEER: | | |
| CUSTOMER: | |  269914 |
| SUBMITTAL DATE: | SPEC. SYMBOL: | 2020/02/10 |

600 SERIES
RETURN ALUMINUM
LOUVERED FACE GRILLE

600 - RETURN ALUMINUM LOUVERED FACE GRILLE

FASTENING:

A - COUNTER SUNK SCREW

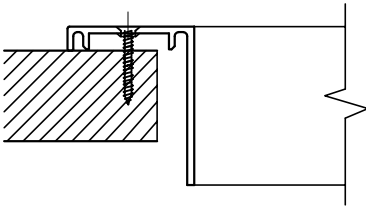

AVAILABLE ON FRAMES F AND N

C - CONCEALED BRACKET

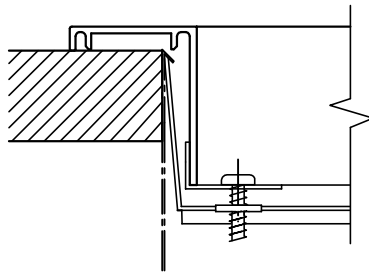

MAX. SIZE 24"x24" (610x610)
NOT AVAILABLE WITH MODEL 635

O - NO FASTENING FOR LAY-IN APPLICATIONS OR FASTENING BY OTHERS

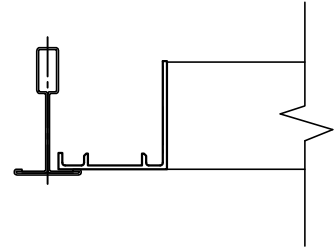

OPTIONS:

SR - ROUND NECK ADAPTOR
COATED STEEL CONSTRUCTION - MILL FINISH

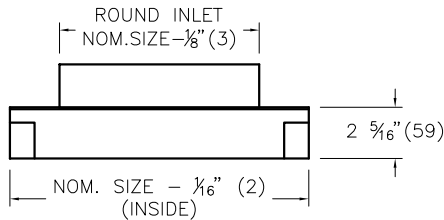

RAS - RETURN AIR SILENCER
COATED STEEL CONSTRUCTION - MILL FINISH

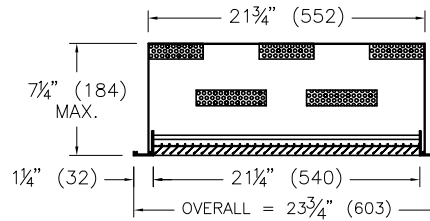

AVAILABLE WITH 22"x22" (559x559) SIZE ONLY
NOT AVAILABLE WITH OPPOSED BLADE DAMPER

LS - LIGHT SHIELD
STEEL CONSTRUCTION - BLACK FINISH

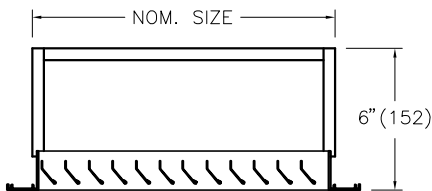

NOT AVAILABLE WITH OPPOSED BLADE DAMPER

MRI COMPATIBLE CONSTRUCTION (AVAILABLE ON 630 AND 635 ONLY, NOT AVAILABLE WITH C MOUNTING, OPPOSED BLADE DAMPER, OR OPTIONS RAS, LS, IS OR SR, MAXIMUM SIZE 48"x48" (1219x1219))

IS - INSECT SCREEN 18/16 MESH
NOT AVAILABLE WITH OPPOSED BLADE DAMPER
MAXIMUM SIZE 48"x48" (1219x1219)

DAMPERS:

VCS3 - COATED STEEL VCS3
OPPOSED BLADE DAMPER
 VCS3AL - ALUMINUM VCS3AL OPPOSED
BLADE DAMPER (MILL FINISH)

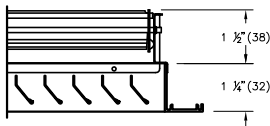

NOTES:

- TYPE A FASTENING - COUNTERSUNK SCREW HOLES FOR #8 SCREWS PER FACTORY STANDARD (SCREWS SUPPLIED)
- GRILLES ARE ORDERED BY NOMINAL DUCT SIZE, FOR MODULE SIZE DETAILS IN LAY-IN APPLICATIONS SEE PAGE 2
- ONLY ONE OF OPTIONS LS, IS, RAS AND SR MAY BE SELECTED, AND ARE NOT AVAILABLE WITH C MOUNTING
- C MOUNTING, RAS, SR AND LS - STEEL CONSTRUCTION
- FACTORY TOLERANCE ± 1/32" (1)

FINISH:

B12 WHITE (OPTIONAL FINISHES AVAILABLE)

ALL METRIC DIMENSIONS () ARE SOFT CONVERTED. IMPERIAL DIMENSIONS ARE CONVERTED TO METRIC AND ROUNDED TO THE NEAREST MILLIMETER.

| | | | |
|------------------------|----------------------|---------------|--|
| PROJECT: | | price® | |
| ENGINEER: | | 269914 | 600 SERIES RETURN ALUMINUM LOUVERED FACE GRILLE |
| CUSTOMER: | | | |
| SUBMITTAL DATE: | SPEC. SYMBOL: | 2020/02/10 | |

600 - RETURN ALUMINUM LOUVERED FACE GRILLE

MULTI-SECTION CONSTRUCTION FOR LARGE SURFACE MOUNT SIZES

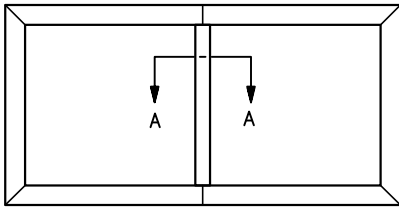

ONE DIMENSION OVER 48" (1219)
SIZES UP TO 96"x48" (2438x1219)
TWO SECTIONS WITH MULLION

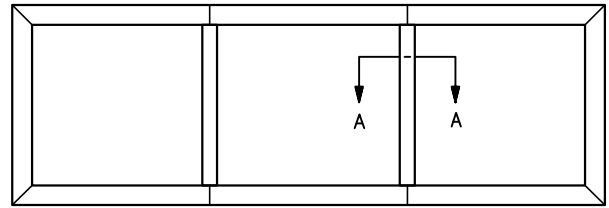

ONE DIMENSION OVER 48" (1219)
SIZES UP TO 144"x48" (3658x1219)
THREE SECTIONS WITH MULLIONS

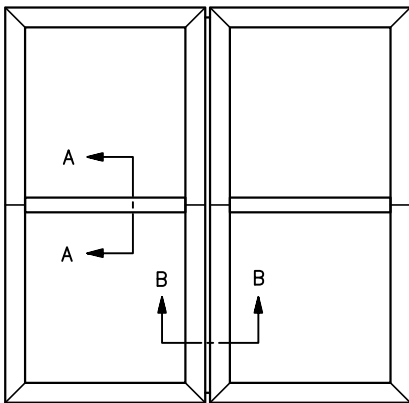

BOTH DIMENSIONS OVER 48" (1219)
UP TO 96"x96" (2438x2438)
MULLIONS AND MOUNTING CHANNEL

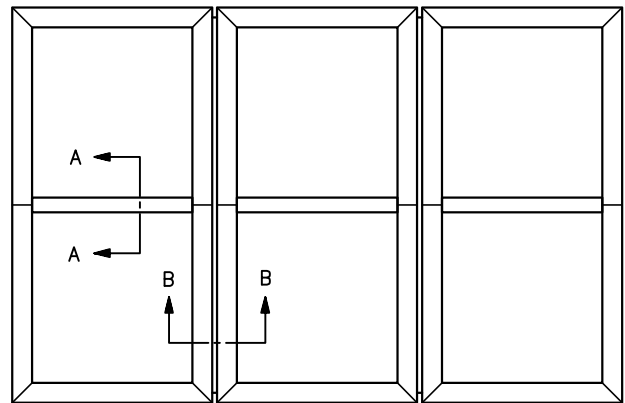

BOTH DIMENSIONS OVER 48" (1219)
UP TO 144"x96" (3658x2438)
MULLIONS AND MOUNTING CHANNEL

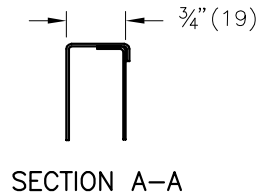
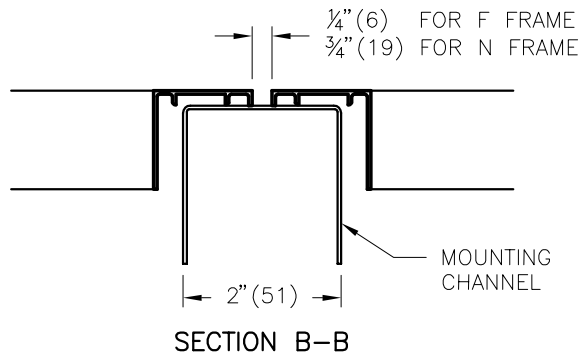
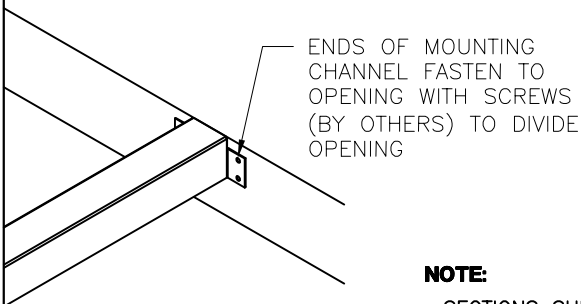

NOTE:

- SECTIONS SHIP LOOSE FOR FIELD INSTALLTION
- DUCT MOUNTING CHANNELS PROVIDED IN ALUMINIUM (OTHER MATERIALS AVAILABLE AS SPECIAL ORDER)

ALL METRIC DIMENSIONS () ARE SOFT CONVERTED. IMPERIAL DIMENSIONS ARE CONVERTED TO METRIC AND ROUNDED TO THE NEAREST MILLIMETER.

| | | | |
|------------------------|----------------------|---------------|--|
| PROJECT: | | PRICE® | |
| ENGINEER: | | 269914 | 600 SERIES RETURN ALUMINUM LOUVERED FACE GRILLE |
| CUSTOMER: | | | |
| SUBMITTAL DATE: | SPEC. SYMBOL: | 2020/02/10 | |